

micro-1400

Part Number: LD-1400-12-LT-230-RD

The micro-1400 is part of the LEDdrive range from Mode Lighting. It is a mains dimmable constant current power supply unit designed to drive high brightness LEDs.

All LEDdrive power supplies are dimmable by both leading and trailing edge dimmers (subject to a minimum load). This model provides a constant current of 1400mA with a series output voltage of 4V to 12V.



- ▶ 1400mA constant current output.
- ▶ Mains dimmable by leading or trailing edge.
- ▶ High power factor.
- ▶ Short circuit and open circuit protection.
- ▶ High efficiency which ensures a cool operating temperature.
- ▶ Flame retardant moulded enclosure, UL94-V0.
- ▶ Compact size suitable for Ø 50mm cut-out.
- ▶ Five year guarantee.
- ▶ CE Compliant to EC EMC and Low Voltage directives.
- ▶ Complies with EMC harmonics standard, voltage fluctuation standard, emission standard and immunity standard.
- ▶ Complies with EN 61347-2-13 electrical safety standard.
- ▶ Low audible noise throughout the dimming range.

Efficiency

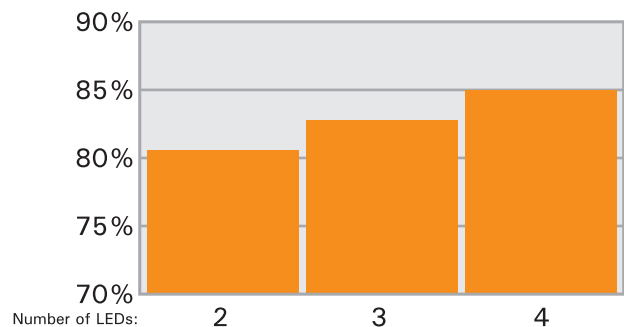

Power Factor

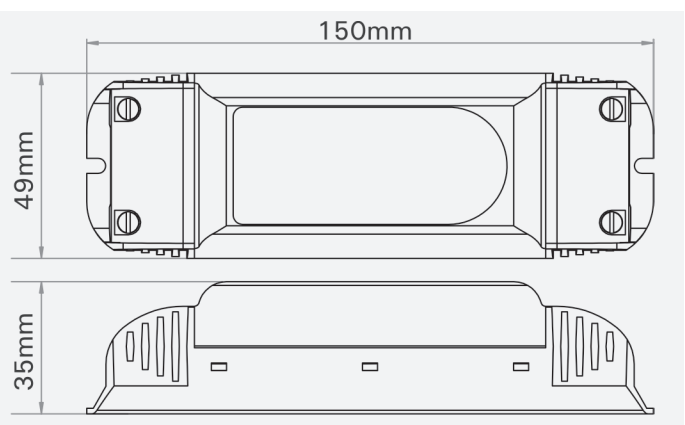
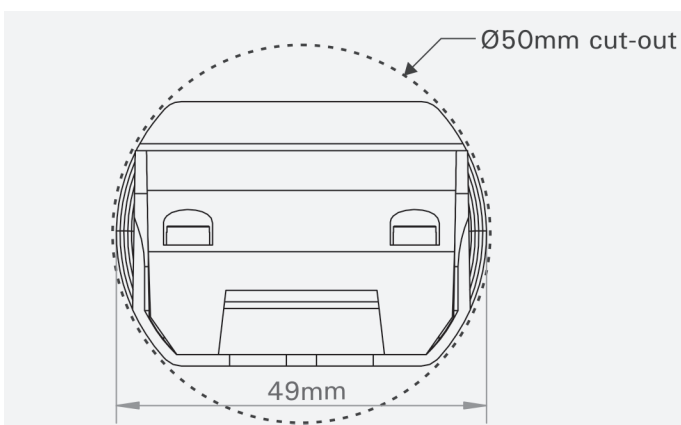
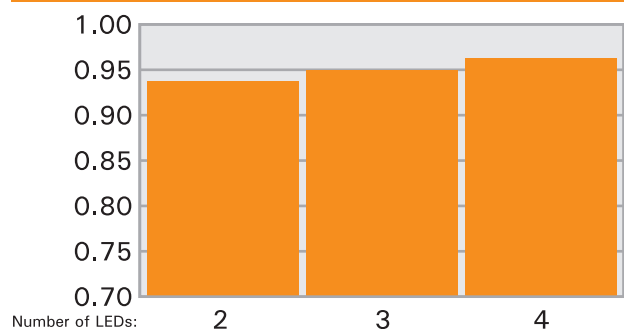

Wiring Diagrams

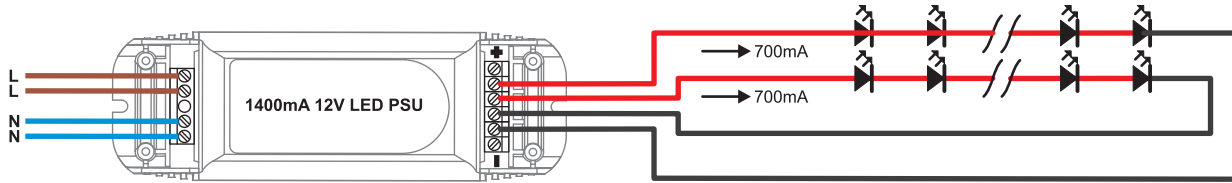
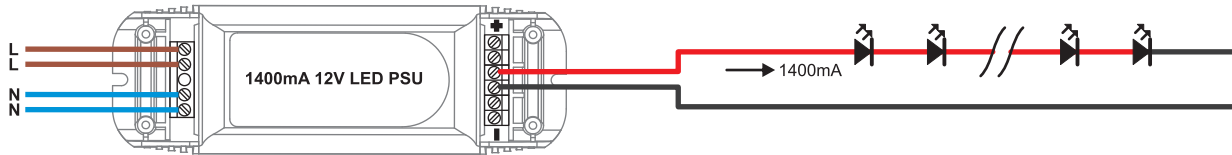

IMPORTANT: Each output MUST drive the same number of LEDs.

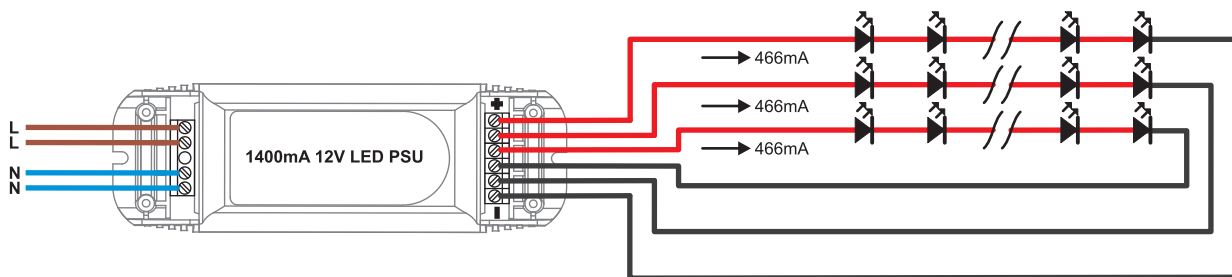

IMPORTANT: Each output MUST drive the same number of LEDs.

Technical Specification: LD-1400-12-LT-230-RD

Mains Input Voltage	230 Volt +/- 10% 50/60Hz
Mains Input Current	0.1 Amp Maximum
Input Connections	2 x Live, 2 x Neutral Screw Terminals for 0.5 to 2.5mm ²
Power Factor at Full Load	0.96 Typical
Efficiency at Full Load	83% Typical
Mains Protection	4KV Fast Transient, 2KV Surge
Input-Output Isolation	Double Insulated, 4KV AC RMS
Ambient Temperature (Ta)	45°C Maximum
Case Temperature (Tc)	80°C Maximum
Humidity	95% Maximum Non-Condensing
Maximum Output Power	16.8W
Output Current at Full Load	1400mA
LED Series Voltage	SELV, 4V to 12V DC. Quantity of LEDs dependant on Vf.
Enclosure	Black Polycarbonate UL94-V0 IP20
Dimensions	49mm (width) x 35mm (height) x 150mm (length),
Maximum Cut Out	Ø 50mm
Fixings	Fixing Centre 143mm, Ø4mm slot
Output Connections	3x (+) 3x (-) Screw Terminals for 0.5 to 2.5mm ²
Weight	140g
Standards (EC EMC and Low Voltage Directives)	EN55015 EMC Emission, EN61547 EMC Immunity, EN61000-3-2 Class C Harmonics, EN61000-3-3 Voltage Fluctuation and EN61347-2-13 Electrical Safety